



## *Super Capacity 465*

4.65 Cubic Foot Oven

MODEL RF315PXE

PART NO. 3196273 Rev. B

**TimeSmart**<sup>®</sup>  
Tips Inside!

# Use & Care

G U I D E

## Standard-Cleaning Electric Range

A Note to You ..... 2

Range Safety ..... 3-5

Parts and Features ... 6

Using Your Range ..... 7

Caring for Your  
Range ..... 24

Troubleshooting ..... 32

Requesting  
Assistance or  
Service ..... 34

Index ..... 35

Warranty ..... 36

**1-800-253-1301**

Call our Consumer Assistance Center  
with questions or comments.



Making Your World  
A Little Easier.™

[www.WhirlpoolAppliances.com](http://www.WhirlpoolAppliances.com)

# A NOTE TO YOU

## Thank you for buying a WHIRLPOOL® appliance.

Because your life is getting busier and more complicated, WHIRLPOOL appliances are easy to use, save time, and help you manage your home better. To ensure that you enjoy years of trouble-free operation, we developed this Use and Care Guide. It is full of valuable information about how to operate and maintain your appliance properly and safely. Please read it carefully.

Also, complete and mail the **Product Registration Card** provided with your appliance. The card helps us notify you about any new information on your appliance.

## Please record your model's information.

Whenever you call to request service for your appliance, you need to know your complete model number and serial number. You can find this information on the model and serial number label/plate (see the diagram in the "Parts and Features" section). Also, record the other information shown in the next column.

**TimeSmart® TIPS**

*Look for these tips!*

Look for these Time Smart Tips located throughout your Use and Care Guide. They will help you save time and make the most of your new appliance.

**Model Number** \_\_\_\_\_

**Serial Number** \_\_\_\_\_

**Purchase Date** \_\_\_\_\_

**Dealer Name** \_\_\_\_\_

**Dealer Address** \_\_\_\_\_

**Dealer Phone** \_\_\_\_\_

**Keep this book and the sales slip together in a safe place for future reference.**

**Our Consumer Assistance Center number is toll free.** **1-800-253-1301**

To find detailed product information, the location of the nearest Whirlpool dealer or authorized servicer, to purchase an accessory item, or register your appliance on-line, please visit our Web site at [www.WhirlpoolAppliances.com](http://www.WhirlpoolAppliances.com)

# RANGE SAFETY

## Your safety and the safety of others is very important.

We have provided many important safety messages in this manual and on your appliance. Always read and obey all safety messages.



This is the safety alert symbol.

This symbol alerts you to hazards that can kill or hurt you and others.

All safety messages will be preceded by the safety alert symbol and the word "DANGER" or "WARNING." These words mean:

**⚠ DANGER**

You **will** be killed or seriously injured if you don't follow instructions.

**⚠ WARNING**

You **can** be killed or seriously injured if you don't follow instructions.

All safety messages will identify the hazard, tell you how to reduce the chance of injury, and tell you what can happen if the instructions are not followed.



## ⚠ WARNING

### Tip Over Hazard

A child or adult can tip the range and be killed.

Connect anti-tip bracket to rear range foot.

Reconnect the anti-tip bracket, if the range is moved.

See the installation instructions for details.

Failure to follow these instructions can result in death or serious burns to children and adults.

### Anti-Tip Bracket



Range Foot

Making sure the anti-tip bracket is installed:

- Slide range forward.
- Look for the anti-tip bracket securely attached to floor.
- Slide range back so rear range foot is under anti-tip bracket.

continued on next page

## IMPORTANT SAFETY INSTRUCTIONS

**WARNING:** To reduce the risk of fire, electrical shock, injury to persons, or damage when using the range, follow basic precautions, including the following:

- **WARNING – TO REDUCE THE RISK OF TIPPING OF THE RANGE, THE RANGE MUST BE SECURED BY PROPERLY INSTALLED ANTI-TIP DEVICES. TO CHECK IF THE DEVICES ARE INSTALLED PROPERLY, SLIDE RANGE FORWARD, LOOK FOR ANTI-TIP BRACKET SECURELY ATTACHED TO FLOOR, AND SLIDE RANGE BACK SO REAR RANGE FOOT IS UNDER ANTI-TIP BRACKET.**
- **CAUTION –** Do not store items of interest to children in cabinets above a range or on the backguard of a range – children climbing on the range to reach items could be seriously injured.
- Proper Installation – Be sure the range is properly installed and grounded by a qualified technician.
- Never Use the Range for Warming or Heating the Room.
- Do Not Leave Children Alone – Children should not be left alone or unattended in area where the range is in use. They should never be allowed to sit or stand on any part of the range.
- Wear Proper Apparel – Loose-fitting or hanging garments should never be worn while using the range.
- User Servicing – Do not repair or replace any part of the range unless specifically recommended in the manual. All other servicing should be referred to a qualified technician.
- Storage in or on the Range – Flammable materials should not be stored in an oven or near surface units.
- Do Not Use Water on Grease Fires – Smother fire or flame or use dry chemical or foam-type extinguisher.
- Use Only Dry Potholders – Moist or damp potholders on hot surfaces may result in burns from steam. Do not let potholder touch hot heating elements. Do not use a towel or other bulky cloth.
- DO NOT TOUCH SURFACE UNITS OR AREAS NEAR UNITS – Surface units may be hot even though they are dark in color. Areas near surface units may become hot enough to cause burns. During and after use, do not touch, or let clothing or other flammable materials contact surface units or areas near units until they have had sufficient time to cool. Among those areas are the cook-top and surfaces facing the cook-top.
- Use Proper Pan Size – The range is equipped with one or more surface units of different size. Select utensils having flat bottoms large enough to cover the surface unit heating element. The use of undersized utensils will expose a portion of the heating element to direct contact and may result in ignition of clothing. Proper relationship of utensil to burner will also improve efficiency.
- Never Leave Surface Units Unattended at High Heat Settings – Boilover causes smoking and greasy spillovers that may ignite.
- Make Sure Reflector Pans or Drip Bowls Are in Place – Absence of these pans or bowls during cooking may subject wiring or components underneath to damage.
- Protective Liners – Do not use aluminum foil to line surface unit drip bowls or oven bottoms, except as suggested in the manual. Improper installation of these liners may result in a risk of electric shock, or fire.
- Glazed Cooking Utensils – Only certain types of glass, glass/ceramic, ceramic, earthenware, or other glazed utensils are suitable for range-top service without breaking due to the sudden change in temperature.
- Utensil Handles Should Be Turned Inward and Not Extend Over Adjacent Surface Units – To reduce the risk of burns, ignition of flammable materials, and spillage due to unintentional contact with the utensil, the handle of a utensil should be positioned so that it is turned inward, and does not extend over adjacent surface units.
- Do Not Soak Removable Heating Elements - Heating elements should never be immersed in water.

– SAVE THESE INSTRUCTIONS –

## IMPORTANT SAFETY INSTRUCTIONS

- Use Care When Opening Door – Let hot air or steam escape before removing or replacing food.
- Do Not Heat Unopened Food Containers – Build-up of pressure may cause container to burst and result in injury.
- Keep Oven Vent Ducts Unobstructed.
- Placement of Oven Racks – Always place oven racks in desired location while oven is cool. If rack must be moved while oven is hot, do not let potholder contact hot heating element in oven.
- DO NOT TOUCH HEATING ELEMENTS OR INTERIOR SURFACES OF OVEN – Heating elements may be hot even though they are dark in color. Interior surfaces of an oven become hot enough to cause burns. During and after use, do not touch, or let clothing or other flammable materials contact heating elements or interior surfaces of oven until they have had sufficient time to cool. Other surfaces of the appliance may become hot enough to cause burns – among these surfaces are oven vent openings and surfaces near these openings, oven doors, and windows of oven doors.

### For self-cleaning ranges –

- Do Not Clean Door Gasket – The door gasket is essential for a good seal. Care should be taken not to rub, damage, or move the gasket.
- Do Not Use Oven Cleaners – No commercial oven cleaner or oven liner protective coating of any kind should be used in or around any part of the oven.
- Clean Only Parts Listed in Manual.
- Before Self-Cleaning the Oven – Remove broiler pan and other utensils.

### For units with ventilating hood –

- Clean Ventilating Hoods Frequently – Grease should not be allowed to accumulate on hood or filter.
- When flaming foods under the hood, turn the fan off. The fan, if operating, may spread the flame.

– SAVE THESE INSTRUCTIONS –

# PARTS AND FEATURES

This section contains captioned pictures of your range. Use them to learn where all parts and features are and what they look like. Use the page references to help you quickly find out more about the part or feature you are interested in.

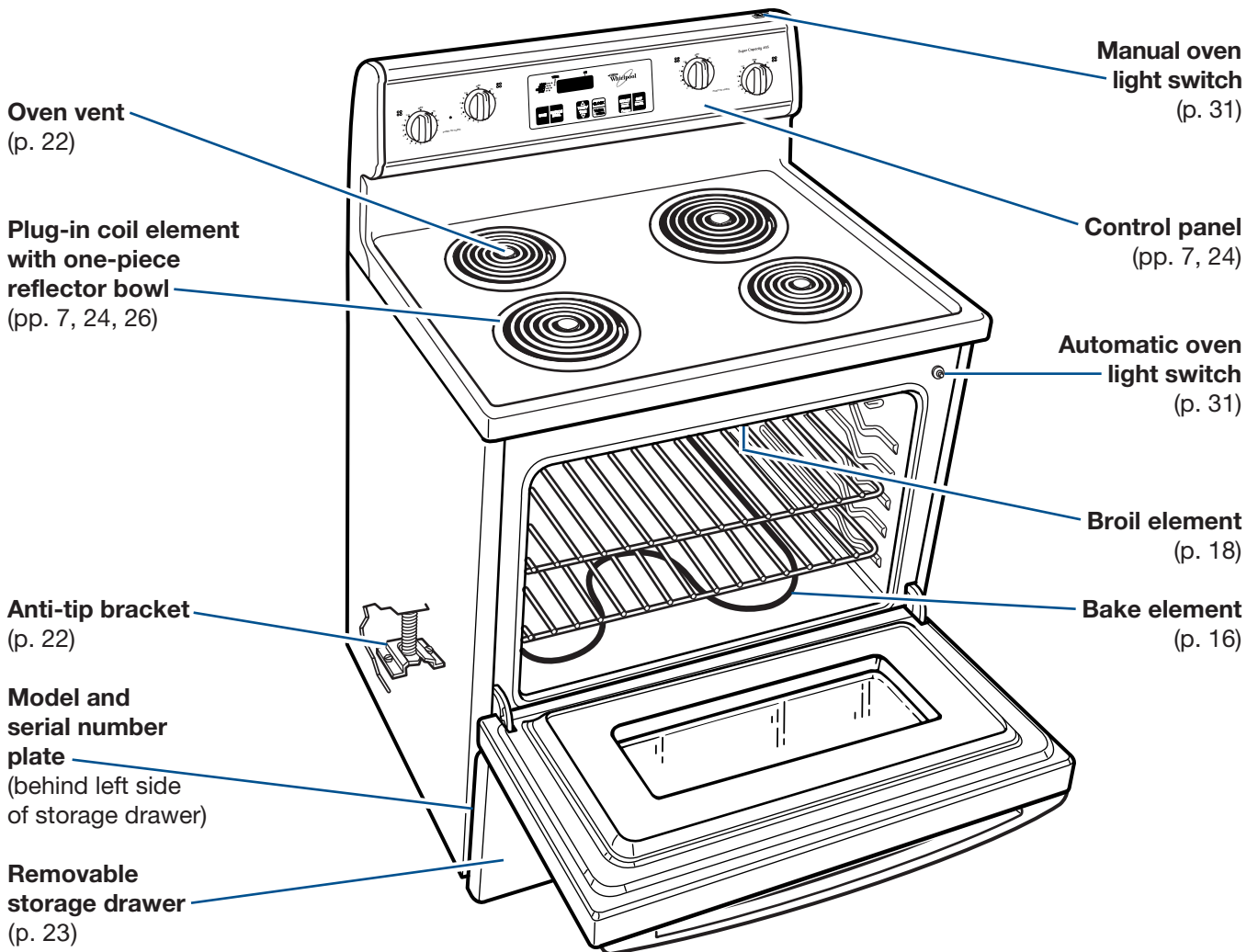

## CONTROL PANEL

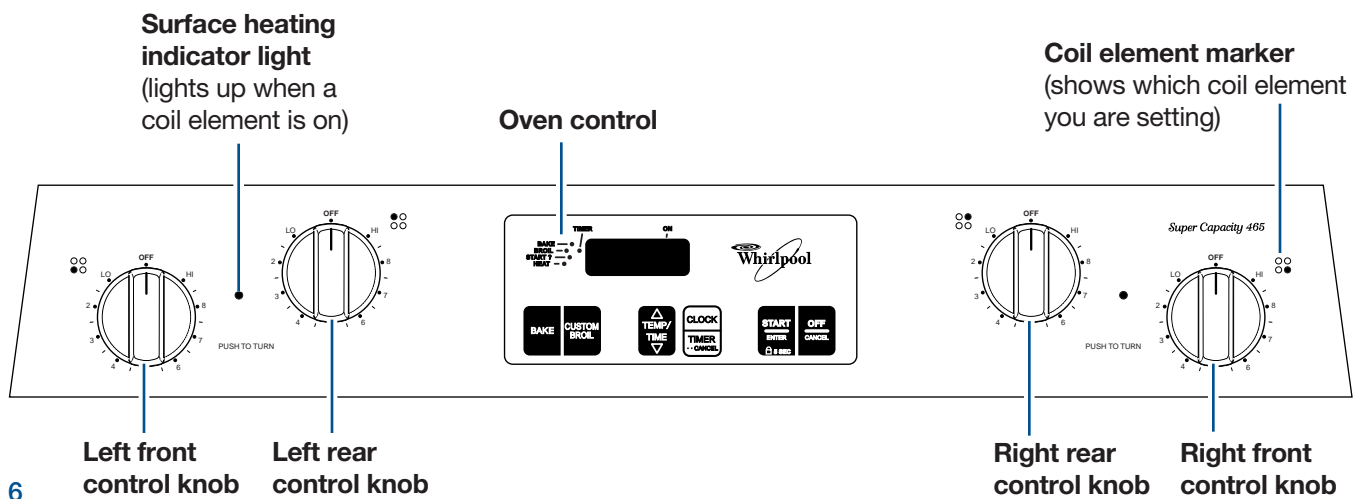

# USING YOUR RANGE

To get the best cooking results, you should use your range the correct way. This section tells you what you need to know to use your range safely and efficiently.

## USING THE COIL ELEMENTS

### Using the control knobs

Push in the control knobs before turning them to a setting. You can set them anywhere between HI and OFF.

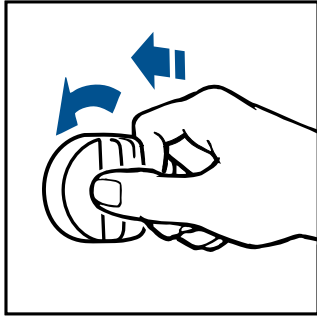

### Coil element heat settings

Use the following chart as a guide.

SETTING	RECOMMENDED USE
HI	<ul style="list-style-type: none"><li>● To start foods cooking.</li><li>● To bring liquids to a boil.</li></ul>
6-8	<ul style="list-style-type: none"><li>● To hold a rapid boil.</li><li>● To fry chicken or pancakes.</li></ul>
5	<ul style="list-style-type: none"><li>● For gravy, pudding, and icing.</li><li>● To cook large amounts of vegetables.</li></ul>
2-4	<ul style="list-style-type: none"><li>● To keep food cooking after starting it on a higher setting.</li></ul>
LO	<ul style="list-style-type: none"><li>● To keep food warm until it's ready to serve.</li></ul>

### **!**WARNING



#### Fire Hazard

Turn off all controls when done cooking.  
Failure to do so can result in death or fire.

### TimeSmart® TIPS

#### Easy ways to save energy

- Match the pan to the coil element size.
- The pan should have a flat bottom, straight sides, and a well-fitting lid.
- To help shorten your cooking time, use the least amount of liquid possible.
- Preheat your pots and pans only when recommended and for the shortest time possible.
- Start your food on a higher heat setting, then turn the control to a lower setting to finish cooking.
- Place a filled pan on the coil element before turning it on.
- Keep your reflector bowls clean for best heat reflection.

## USING THE COIL ELEMENTS (CONT.)

### Using cookware

- Use the correct cookware to prevent damage to the coil element, cooktop, wiring, and surrounding areas.
- If the cookware is too small for the coil element or the bottom is not flat, the coil element could stay glowing red for an extended length of time causing damage to the range.
- If you start cooking on high, it is important to turn the control down to a lower setting to complete cooking.
- The coil element could overheat or be damaged if a pot has boiled dry or has been left empty on a hot coil element.

### TimeSmart® TIPS

#### Using the right cookware makes a big difference

- Flat bottomed cookware, including woks, canners, and teakettles, will provide better contact with the coil element and provide the best cooking results.
- Warped, dented, and ribbed-bottomed cookware can result in uneven cooking due to incomplete contact with the coil element.
- Cookware that has been designed with slightly indented bottoms or small expansion channels can be used.
- Choose medium to heavy gauge (thickness) cookware.
- The pan material (type of metal or glass) affects how quickly and evenly the pan heats.

### Home canning information

#### To protect your range:

- Use flat-bottomed canners/pans for best results.
  - Use the largest coil element for best results. Also, use a canner/pan that you can center over the coil element and that does not extend more than 1 inch outside the coil element area. Large diameter canners/pans, if not centered correctly, trap heat and can cause damage to the cooktop.

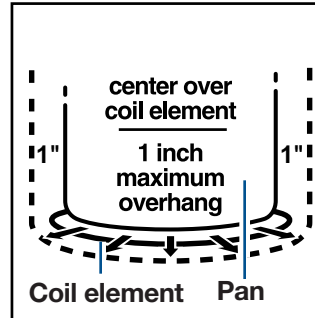

- Do not place your canner on 2 coil elements at the same time. Too much heat will build up and damage the cooktop.

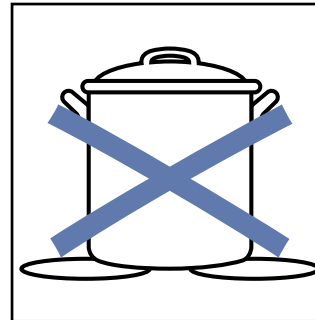

- Start with hot water. This reduces the time the control is set on high. Reduce the heat setting to the lowest position needed to keep water boiling.

- When canning for long periods of time, alternate use of the coil elements between batches to allow the coil elements to cool down, or prepare food in small batches.
- Keep your reflector bowls clean so that they will always reflect heat well.
- Refer to your canner manual for specific instructions.

### Optional canning kit

Most water-bath or pressure canners have large diameters. If you do canning with them at high heat settings for long periods of time, you can shorten the life of regular coil elements. This can damage the cooktop. If you plan to use the cooktop for canning, we recommend the installation of a Canning Kit. Order the kit (Part No. 242905) from your Whirlpool dealer or authorized Whirlpool service company.



# POSITIONING RACKS AND PANS

## General guidelines

Follow this section carefully to get the best cooking results.

- Before turning on the oven, place oven racks where you need them.
- To move a rack, pull it out to the stop, raise the front edge, and lift it out.
- Be sure the rack(s) is level.
- Use pot holders or oven mitts to protect your hands if rack(s) must be moved while the oven is hot.
- When baking/roasting with 1 rack, place the rack so the top of the food will be centered in the oven.
- When baking/roasting on 2 racks, position racks in oven to allow good circulation of air around all the food.
- Do not place items on the oven door when it is open.

## Rack placement for specific foods:

FOOD	RACK POSITION
Frozen pies, large roasts, turkeys, angel food cakes	1st or 2nd rack guide from bottom
Bundt cakes, most quick breads, yeast breads, casseroles, meats	2nd rack guide from bottom
Cookies, biscuits, muffins, cakes, nonfrozen pies	2nd or 3rd rack guide from bottom

**NOTE:** For information on where to place your rack when broiling, see “Broiling guide” later in this section.

### TimeSmart® TIPS

#### *Using insulated bakeware, ovenproof glassware, and dark metal pans*

- When baking with insulated cookie sheets or baking pans, place them in the bottom third of the oven. You may need to increase the recommended baking times, so test for doneness before removing from the oven.
- When using ovenproof glassware or dark bakeware, reduce the oven temperature by 25°F but use the same baking time. Because these pans absorb heat, producing darker bottom browning and crispier crusts, place the rack in the center of the oven. When baking pies and bread, you can use the temperature suggested in the recipe.

## FOR BEST AIR CIRCULATION

Hot air must circulate around the pans in the oven for even heat to reach all parts of the oven. This results in better baking.

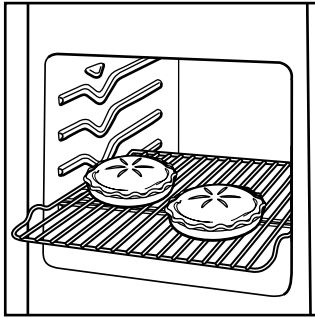

- Place the pans so that one is not directly over the other.
- For best results, allow 1½-2 inches of space around each pan and between pans and oven walls.

- For best baking results, bake 1 sheet of cookies at a time.

### Where to place pans:

WHEN YOU HAVE	PLACE
1 pan	In center of the oven rack.
2 pans	Side by side or slightly staggered.
3 or 4 pans	In opposite corners on each oven rack. Stagger pans so no pan is directly over another.

## USING ALUMINUM FOIL FOR BAKING

Use aluminum foil to catch spillovers from pies or casseroles:

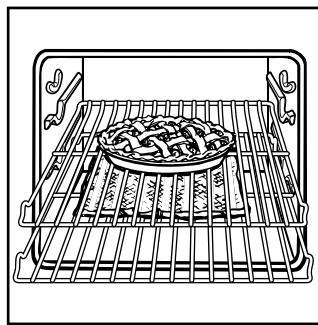

- Place the foil on the oven rack below the rack with the food. Turn up the foil edges and make sure the foil is about 1 inch larger all around than the dish holding the food.
- Do not cover the entire rack with aluminum foil. It will reduce air circulation and give you poor cooking results.

- Do not line the oven bottom or the entire oven rack with foil or other liners. It could affect the quality of your baking.

# THE ELECTRONIC OVEN CONTROL

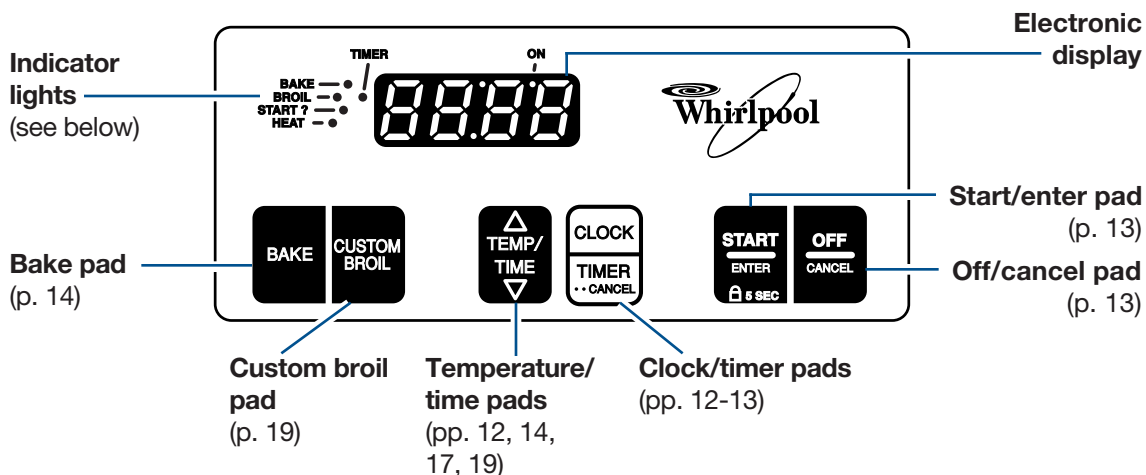

## Display

- When you first plug in the range, “PF” will appear on the display until you press any command pad. If “PF” again appears on the display, your electricity was off for a while. You will need to reprogram any temperature adjustments you may have made. See the “Adjusting the oven temperature control” section.
- When you are using the oven, the display will show preheat times and temperature settings.
- When you are not cleaning or cooking with the oven, the display will show the time of day.
- When setting a function, if you do not press the start/enter pad within 5 seconds, the Start? indicator light will flash. If you do not press the start/enter pad within 5 minutes, the function will be canceled.

## Indicator lights

An indicator light to the left of the display lights up when you are in a setting. An indicator light on the display lights up when the oven is on.

## Using the control lock

The control lock lets you disable the control panel command pads. The control lock comes in handy when you want to prevent others from using the oven.

### NOTES:

- You can only use the control lock when the oven is not in use or the control has not been set.
- Set the control lock when cleaning the control panel to prevent yourself from accidentally turning on the oven.
- You must reset the control lock if the power goes out for more than 1 second.

### To lock the control panel:

Press and hold the start/enter pad for 5 seconds.

 You will hear a single tone and “Loc” will appear on the temperature display for 5 seconds. “Loc” and “START?” will then appear whenever a command pad is pressed.

### To unlock the control panel:

Press and hold the start/enter pad for 5 seconds.

 You will hear a single tone and “Loc” and “START?” will disappear from the temperature display.

## SETTING THE CLOCK

1. Press the clock pad.

PRESS



YOU SEE



2. Set the time.

Press the “up” (▲) or “down” (▼) pad(s) until the correct time shows on the display.

PRESS



YOU SEE



(example for 5:30)

3. Start the clock.

**NOTES:**

- To see the time of day when the clock time is not on the display, press the clock pad.
- You must reset the clock if the power goes off for more than 1 second.

PRESS



OR



YOU SEE



## USING THE MINUTE TIMER

The minute timer does not start or stop the oven. It works like a kitchen timer. You can set the minute timer in hours and minutes up to 12 hours, 59 minutes. The minute timer will display minutes and seconds for settings under 1 hour.

1. Press the timer pad.

The timer indicator light will light up.

PRESS



YOU SEE



2. Set the countdown time.

Press the “up” (▲) or “down” (▼) pad(s) until the correct time shows on the display.

PRESS



YOU SEE



(example for 10 minutes)

## USING THE MINUTE TIMER (CONT.)

3. Start the countdown.

PRESS



OR



YOU SEE



(display counts down)

When the time is up:

You will hear four 1-second tones.

**NOTE:** To see the countdown time when the minute timer is not on the display, press the minute timer pad.

YOU SEE



4. Turn off the minute timer.

PRESS



twice

YOU SEE

(previous display)

**To cancel the minute timer during the countdown**

PRESS



twice

YOU SEE

(previous display)

## STARTING/CANCELING A FUNCTION

After setting a function for the first time, you must press the start/enter pad to start the function.



The off/cancel pad will cancel any function except for the clock, minute timer, or control lock.



# BAKING/ROASTING

- Place the racks where you need them in the oven.  
For more information, see the “Positioning racks and pans” section.

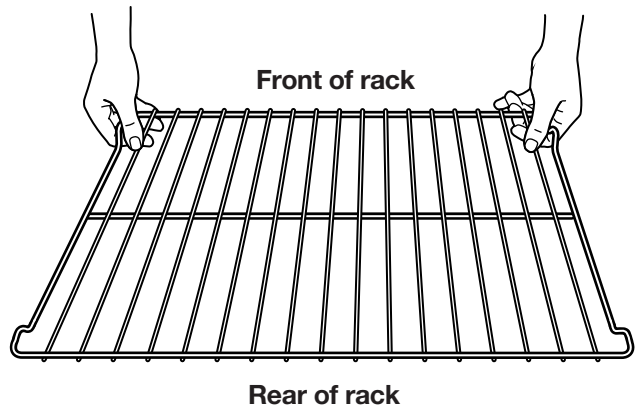

- Choose the bake setting.  
The bake indicator light will light up.

PRESS



YOU SEE



- Set the temperature (optional).  
Do this step if you want to set a temperature other than 350°F. Press ▲ to raise the temperature or ▼ to lower the temperature in 5°F amounts. You can set a temperature anywhere from 170°F to 500°F. Use these pads until the temperature you want shows on the display.

PRESS



YOU SEE



(example for bake at 375°F)

- When roasting, put your food in the oven.  
You do not have to preheat the oven when roasting, unless your recipe recommends it.  
During baking/roasting, the elements will turn on and off to keep the oven temperature at the setting.

**NOTE:** The top element helps heat during baking/roasting, but does not turn red.

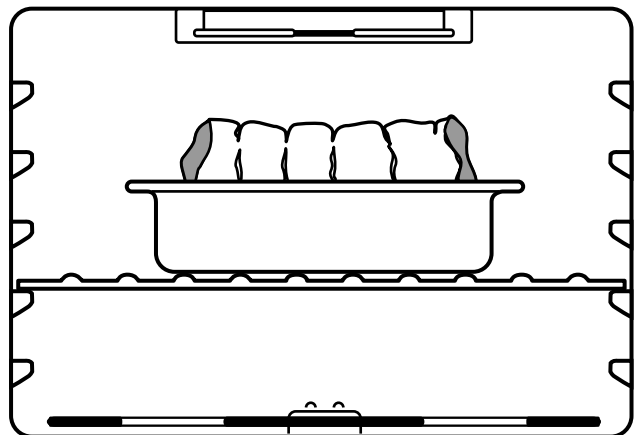

## TimeSmart® TIPS

### Roasting meats and poultry

- For even cooking, place the meat on a rack in a shallow pan. This keeps the meat out of the drippings and allows the heat to circulate better.
- Use a meat thermometer for the most accurate doneness. Insert it so the tip is in the center of the largest muscle or thickest portion of the meat or poultry. Make sure the thermometer is not touching bone, fat, or the bottom of the pan.

## BAKING/ROASTING (CONT.)

### 5. Press the start/enter pad.

A preheating time will count down on the display. The heat, bake, and on indicator lights will light up. The oven control automatically sets preheating times based on the oven temperature you select:

- For 245°F and less, the preheating time is 3 minutes.
- For 250°F-445°F, the preheating time is 6 minutes.
- For 450°F and above, the preheating time is 10 minutes.

The oven is preheated and ready to use when you hear a 1-second tone, the on indicator light goes off, the countdown is finished, and the set temperature is displayed.

The preheat and set temperatures may be different at the end of the countdown. This is normal.

#### NOTES:

- There is no preheating time when the oven temperature is greater than 170°F.
- You can change the temperature setting any time after pressing the start/enter pad. You do not have to press the start/enter pad again.
- The preheating time will not change if you reset the temperature before the countdown time ends.
- If you are baking/roasting while the minute timer is counting down, you can see the set baking/roasting temperature for 5 seconds by pressing the bake pad.

#### PRESS



#### YOU SEE



(example for set temperature of 350°F)

continued on next page

## BAKING/ROASTING (CONT.)

6. When baking, put your food in the oven after the preheat countdown time ends.

During baking/roasting, the elements will turn on and off to keep the oven temperature at the setting.

**NOTE:** The top element helps heat during baking/roasting, but does not turn red.

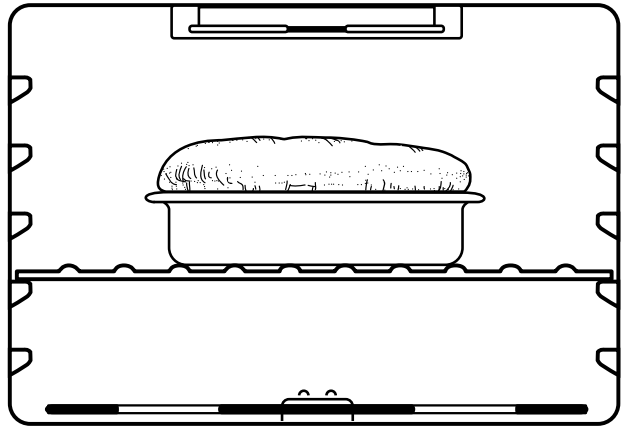

7. After cooking, turn off the oven.

PRESS



YOU SEE

(time of day or minute timer countdown)

### TimeSmart® TIPS

#### Save energy and save money

- “Oven peeking” can make cooking times longer and affect food quality.
- Rely on a timer to keep track of cooking time.
- Plan your meals for the most efficient use of the oven by cooking more than one food at a time, or baking while the oven is still hot after cooking a meal.
- It is not necessary to preheat the oven when broiling or roasting, unless your recipe recommends doing so.



# ADJUSTING THE OVEN TEMPERATURE CONTROL

Although your new oven is properly adjusted to provide accurate temperatures, it may cook faster or slower than your old oven.

If you are not satisfied with the baking/roasting results, you can change the offset temperature by following the steps below.

**NOTE:** DO NOT measure oven temperature with a thermometer. Opening the oven door will lower the oven temperature and give you an incorrect reading. Also, the thermometer temperature reading will change as your oven cycles.

1. Press and hold the bake pad for 4 seconds.  
The display will show 350°F for 4 seconds. Then you will see the current offset temperature, for example “00,” if you have not already adjusted the temperature.

PRESS



YOU SEE



(factory setting of “0”)

2. Set the new offset temperature.  
Press ▲ to raise the temperature or ▼ to lower the temperature in 10°F amounts. You can set the temperature change to as low as -30°F or as high as +30°F. A minus (-) sign will appear before the number when decreasing the temperature setting. The minus sign shows the oven will be cooler by the displayed amount. There is no sign in front of the number when increasing the temperature setting.

PRESS



YOU SEE



(example when making oven 10°F cooler)

3. Enter the adjustment.  
**NOTE:** The offset temperature resets to “00” if the power goes out for more than 1 second.

PRESS



YOU SEE  
(time of day or minute timer countdown)

## How to determine the amount of adjustment needed

The chart at the right tells you how much to adjust the offset temperature to get the cooking results you want. You can figure out cooking results by the amount of browning, moistness, and rising times for baked foods.

TO COOK FOOD ...	ADJUST BY THIS NUMBER OF DEGREES (FAHRENHEIT)
A little more	+10
Moderately more	+20
Much more	+30
A little less	-10
Moderately less	-20
Much less	-30

# BROILING

**NOTES:**

- Do not preheat when broiling, unless your recipe recommends it.
- Leave the door partly open whenever you use the oven to broil. This lets the oven stay at the proper temperatures.
- See “Broiling tips” later in this section.

**1.** Place the rack where you need it.

You need to place the rack so that the surface of the food is at least 3 inches away from the broil element. See “Broiling guide” later in this section.

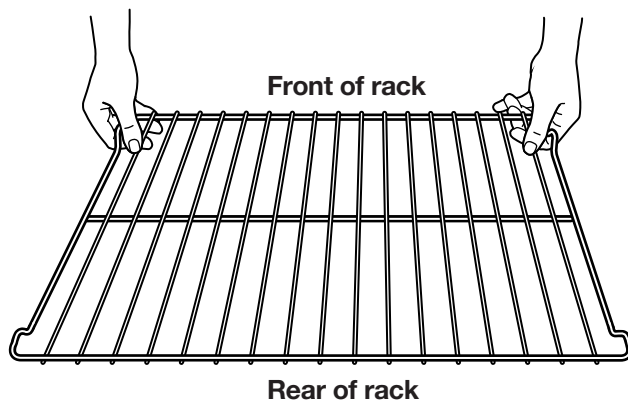

**2.** Put your food on the broiler pan and place the pan in the center of the oven rack.

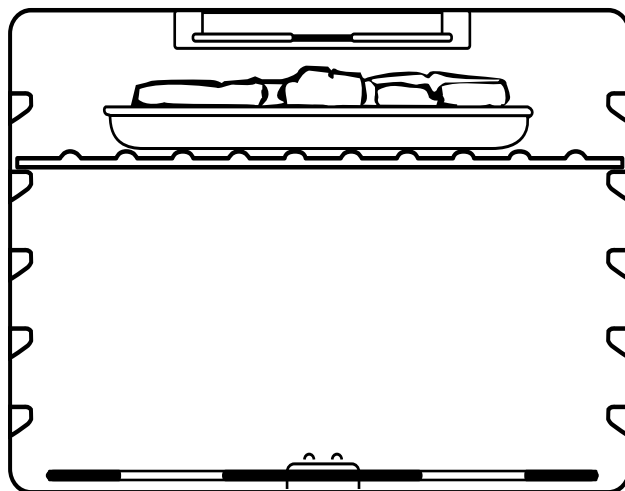

**3.** Close the door to the broil stop position.

The broil stop position lets the door stay open by itself about 5 inches.

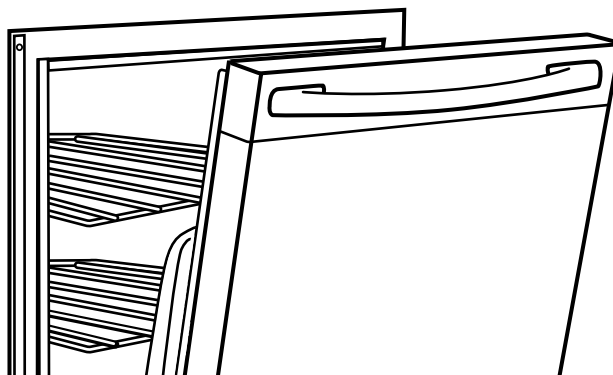

## BROILING (CONT.)

4. Press the custom broil pad.  
The broil indicator light will light up.

PRESS



YOU SEE



5. Start the oven.  
The on and heat indicator lights will light up.

PRESS



YOU SEE



**NOTES:**

- You can change the temperature setting any time after pressing the start/enter pad. To change the setting, see “To custom broil at a lower temperature” below.
- If you are broiling while the minute timer is counting down, you can see the set broiling temperature for 5 seconds by pressing the custom broil pad.

6. When broiling is done, turn off the oven.

PRESS



YOU SEE

(time of day or minute timer countdown)

### To custom broil at a lower temperature:

- If food is cooking too fast, press the custom broil pad and press the ▼ temp pad until “325°F” shows on the display.

PRESS



YOU SEE



(example shows broil at 325°F)



- If you want food to broil slower from the start, press the custom broil pad and press the ▼ temp pad so a temperature between 300°F and 500°F shows on the display. Press the start/enter pad.

Lower temperature settings let the broil burner cycle and slow cooking. The lower the temperature, the slower the cooking.

**NOTE:** Fish and chicken are some foods that may cook better if you use lower broiling temperatures.

PRESS



YOU SEE



(example shows broil at 400°F)



## BROILING TIPS

- Use the broiler pan and grid for broiling. They are designed to drain extra liquid and grease away from the cooking surface. This drainage helps prevent spatter or smoke.
- Do not cover the broiler grid with foil.
- To make sure the grease drains well, do not use cookie sheets or similar pans for broiling.
- Place food about 3 inches or more from the broil element.
- After broiling, remove the broiler pan from the oven when you remove the food. Drippings will bake on the pan if you leave it in the heated oven.

### Broiling guide

Recommended rack positions are numbered from the bottom (1) to the top (5). For best results, turn meat after approximately  $\frac{2}{3}$  of the broiling time. Turn chicken pieces after approximately half of the broiling time. Very thin cuts, such as fish fillets, may not need to be turned at all. Lobster tails are not turned.

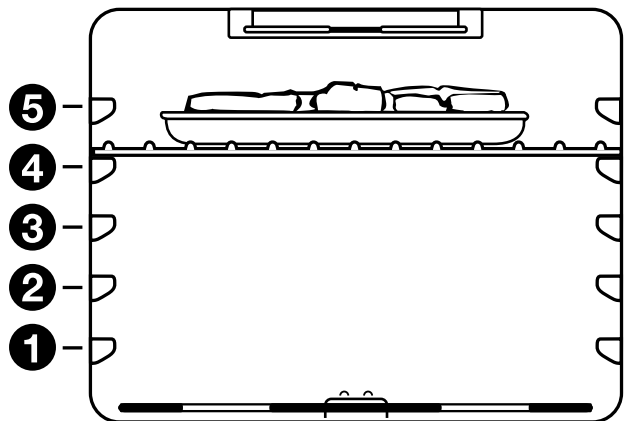

## BROILING TIPS (CONT.)

### Broiling guide (CONT.)

MEAT	RACK POSITION	APPROXIMATE TIME (MINUTES)	
		SIDE 1	SIDE 2
<b>Steak, 1" thick</b>	4		
medium rare		14-15	7-8
medium		15-16	8-9
well done		18-19	9-10
<b>Hamburger Patties, ¾" thick, ¼ lb well done</b>	4	13-14	7-8
<b>Pork Chops, 1" thick</b>	4	20-22	10-11
<b>Ham Slice, ½" thick, precooked</b>	4	8-10	4-5
<b>Frankfurters</b>	4	5-7	3-4
<b>Lamb Chops, 1" thick</b>	4	14-17	8-9
<b>Chicken</b>			
bone-in pieces	3	17-20	17-20
boneless breasts	4	11-16	11-16
<b>Fish</b>	4		
fillets ¼-½" thick		8-10	4-5
steaks ¾-1" thick		16-18	8-9
<b>Lobster Tails, 6-8 oz</b>	3	17-20	N/A

Times are guidelines only and may need to be adjusted for individual tastes.

## THE OVEN VENT

### ⚠ WARNING

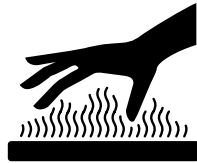

#### Burn Hazard

Use pot holders to move items from left rear surface unit.

Failure to do so can result in burns.

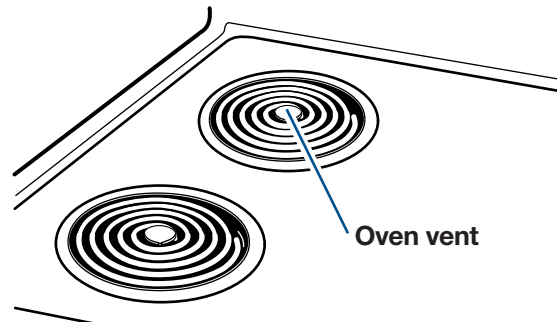

Hot air and moisture escape from the oven through a vent under the left rear coil element. You can cook on this coil element or keep food warm on it while the oven is on. The vent is needed for air circulation. **Do not block the vent by using extra large pans or covers.** You will get poor baking/roasting results.

**NOTE:** Never leave plastic utensils over the vent. They could melt.

## THE ANTI-TIP BRACKET

The range will not tip during normal use. However, the range can tip if you apply too much force or weight to the open door without the anti-tip bracket fastened down properly.

### ⚠ WARNING

#### Tip Over Hazard

A child or adult can tip the range and be killed.

Connect anti-tip bracket to rear range foot.

Reconnect the anti-tip bracket, if the range is moved.

See the installation instructions for details.

Failure to follow these instructions can result in death or serious burns to children and adults.



#### Anti-Tip Bracket

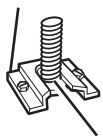

Range Foot

#### Making sure the anti-tip bracket is installed:

- Slide range forward.
- Look for the anti-tip bracket securely attached to floor.
- Slide range back so rear range foot is under anti-tip bracket.

## THE STORAGE DRAWER

Use the storage drawer to store cookware. You can remove the drawer to make it easier to clean under the range. **Be careful when handling the drawer.**

### Removing the storage drawer:

1. Empty the drawer before you remove it. Pull the drawer straight out to the first stop. (The stops are small, round objects formed in the slide rail. They keep the drawer from sliding all the way out.) Then lift the front of the drawer and pull it out to the second stop.
2. Lift the back of the drawer slightly and slide it all the way out.

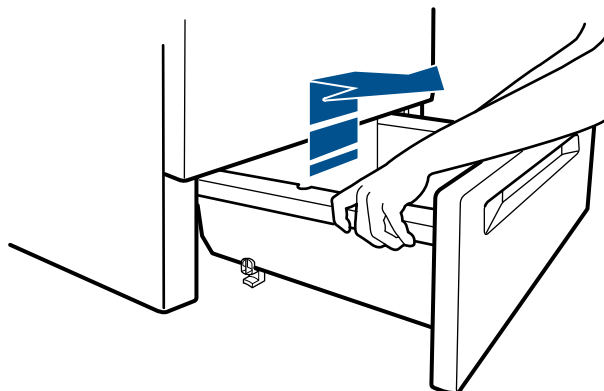

### Replacing the storage drawer:

1. Fit the ends of the drawer slide rails into the drawer guides on both sides of the opening. Also, be sure the lower guide is fitted onto the lower slide rail.
2. Lift the front of the drawer and push it in until the metal stops on the drawer slide rails clear the drawer guides. Then slide the drawer closed.

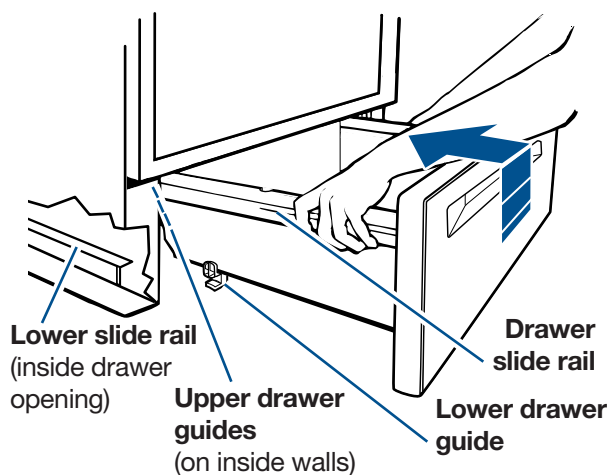

# CARING FOR YOUR RANGE

Your range is designed so you can care for it easily. You can do most cleaning with items found around your home. Cleaning your range whenever spills or soiling occurs will help to keep it looking and working like new.



## ⚠️ WARNING

### Explosion Hazard

Do not store flammable materials such as gasoline near this appliance. Doing so can result in death, explosion, or fire.

## CLEANING CHART

Use this chart to get specific information on cleaning your range. **Before cleaning, always make sure all controls are off and the range is cool.**

PART	HOW TO CLEAN
<b>Control knobs</b>	<ol style="list-style-type: none"><li>1. Turn the knobs off and pull them straight away from the control panel.</li><li>2. Wash the knobs with a sponge and warm, soapy water. Rinse and dry them well. Do not soak them. <b>Do not use steel wool or gritty cleansers</b>, which can damage the finish of the knobs.</li><li>3. Replace the knobs. Make sure all knobs are turned off.</li></ol>
<b>Control panel</b>	<ul style="list-style-type: none"><li>● Wash the panel with a sponge and warm, soapy water. Wipe the panel with clean water and dry it well. <b>Do not use steel wool or gritty cleansers</b>, which can damage the finish.</li></ul> <p><b>OR</b></p> <ul style="list-style-type: none"><li>● Wash the panel with a paper towel and spray glass cleaner. Do not spray the cleaner directly on the panel. Apply the cleaner to the paper towel.</li></ul>
<b>Exterior surfaces</b> (other than control panel)	<ul style="list-style-type: none"><li>● Wash the surface with a sponge and warm, soapy water or paper towel and spray glass cleaner. Wipe with clean water and dry thoroughly. Use a nonabrasive, plastic scrubbing pad on heavily soiled areas.</li><li>● <b>Do not use steel wool, abrasives, or harsh cleansers.</b> They may damage the finish.</li><li>● If you use soap or detergent solutions, wipe thoroughly to prevent filmy residue.</li></ul> <p><b>NOTE:</b> Do not let foods containing acids (such as vinegar, tomato, or lemon juice) remain on the surface. Acids may remove the glossy finish. Also wipe up milk or egg spills when the cooktop is cool. <b>Be careful when cleaning around the model and serial number plate; too much scrubbing could remove the numbers.</b></p>
<b>Coil elements</b>	<ul style="list-style-type: none"><li>● You do not have to clean open coil elements because spatters or spills will burn off.</li><li>● <b>Do not immerse the coil elements in water.</b></li></ul>
<b>Chrome reflector bowls</b> (some models)	<ul style="list-style-type: none"><li>● Wash the reflector bowls with warm, soapy water and a nonabrasive, plastic scrubbing pad. Rinse and dry them well.</li><li>● Clean the reflector bowls often.</li><li>● <b>Do not use gritty or harsh cleansers.</b></li></ul>
<b>Porcelain-enamel reflector bowls</b> (some models)	<ul style="list-style-type: none"><li>● Wipe off excess spills.</li><li>● Wash with a nonabrasive, plastic scrubbing pad and warm, soapy water. Rinse and dry well.</li></ul>



## CLEANING CHART (CONT.)

PART	HOW TO CLEAN
<b>Broiler pan and grid</b>	<ul style="list-style-type: none"> <li>● Wash the pan and grid with a steel-wool pad and warm, soapy water. Rinse and dry well.</li> </ul> <p><b>OR</b></p> <ul style="list-style-type: none"> <li>● Wash the pan and grid in a dishwasher.</li> </ul>
<b>Oven racks</b>	<ul style="list-style-type: none"> <li>● Wash with a steel-wool pad and warm, soapy water. Rinse and dry well.</li> </ul>
<b>Oven door glass</b>	<ul style="list-style-type: none"> <li>● Wash with a paper towel and spray glass cleaner or a nonabrasive plastic scrubbing pad and warm, soapy water. Wipe with clean water and dry well.</li> <li>● Follow the directions that come with the cleaner.</li> </ul>
<b>Oven cavity</b>	<ul style="list-style-type: none"> <li>● Wipe up food spills containing sugar as soon as possible after the oven cools down.</li> <li>● Wash with a sponge or steel-wool pad and warm, soapy water. Wipe with clean water and dry well.</li> </ul> <p><b>OR</b></p> <ol style="list-style-type: none"> <li>1. Clean heavily soiled areas with a commercial oven cleaner. Follow the directions that come with the oven cleaner. (Place newspaper on the floor to protect the floor surface.)</li> <li>2. Wipe well with clean water.</li> </ol> <p><b>NOTES:</b></p> <ul style="list-style-type: none"> <li>● Use oven cleaners in a well-ventilated room.</li> <li>● <b>Do not let commercial oven cleaners contact the gasket, thermostat, or exterior surfaces of the range. This will cause damage.</b></li> <li>● For easier cleaning you can remove the oven door. Carefully follow the instructions in the “Removing the oven door” section.</li> </ul>

## COIL ELEMENTS AND REFLECTOR BOWLS

### Removing

1. Make sure all coil elements are off and cool before removing coil elements and reflector bowls.

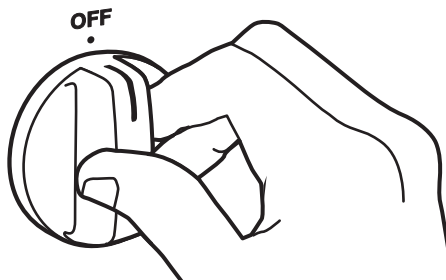

2. Push in the edge of the coil element, opposite the receptacle. Then lift it just enough to clear the reflector bowl.

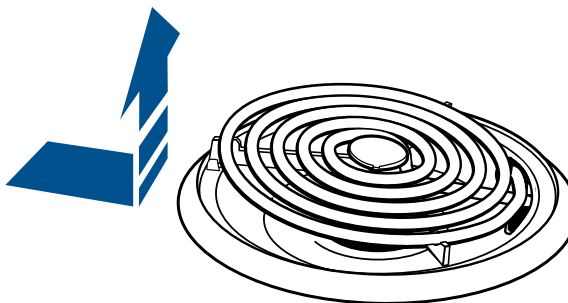

3. Pull the coil element straight away from the receptacle.

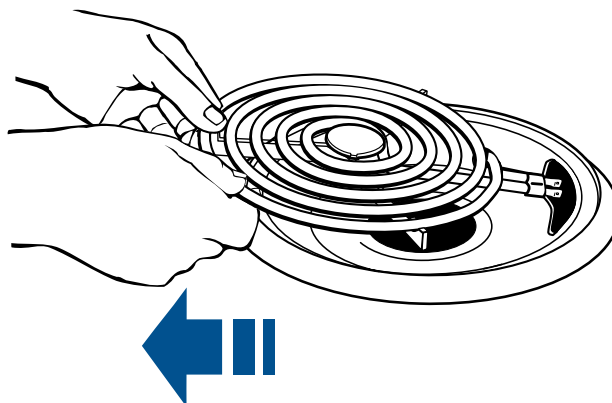

4. Lift out the reflector bowl. See the "Cleaning chart" earlier in this section for cleaning instructions.



## COIL ELEMENTS AND REFLECTOR BOWLS (CONT.)

### Replacing

1. Make sure all coil elements are off and cool before replacing coil elements and reflector bowls.

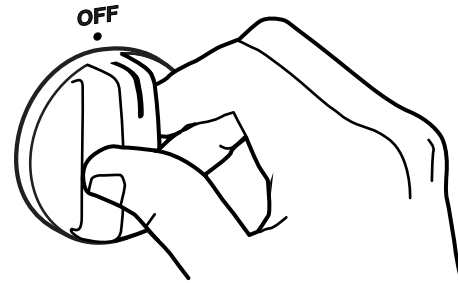

2. Line up openings in the reflector bowl with the coil element receptacle.



3. Hold the coil element as level as possible with the terminal just started into the receptacle. Push the coil element terminal into the receptacle.

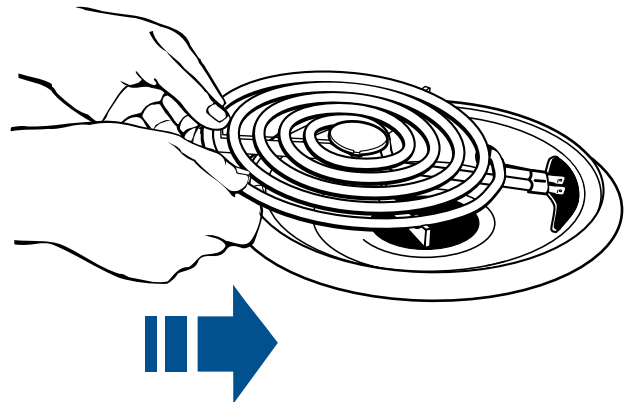

4. When the terminal is pushed into the receptacle as far as it will go, push down the edge of the coil element opposite the receptacle.

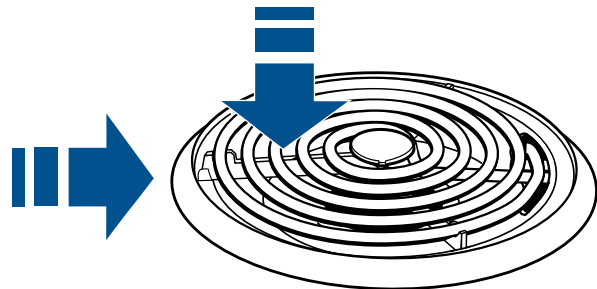

## COIL ELEMENTS AND REFLECTOR BOWLS (CONT.)

**NOTE:** Reflector bowls reflect heat back to the cookware on the coil elements. They also help catch spills. When they are kept clean, they reflect heat better and look new longer.

If a reflector bowl changes color, some of your cookware may not be flat enough, or some may be

too large for the coil element. In either case, some of the heat that's meant to go into or around cookware goes down and heats the reflector bowl. This extra heat can cause it to change color.

## LIFT-UP COOKTOP

**NOTE:** Do not drop the cooktop. Damage could result to the porcelain and the cooktop frame.

1. Lift the front of the cooktop at both front corners until the support rods lock into place.
2. Wipe the surface under the cooktop with warm, soapy water and a sponge. Use a soapy steel-wool pad on heavily soiled areas.
3. To lower the cooktop, lift the cooktop from both sides while pressing the support rods back to unlock them. Lower the cooktop into place.

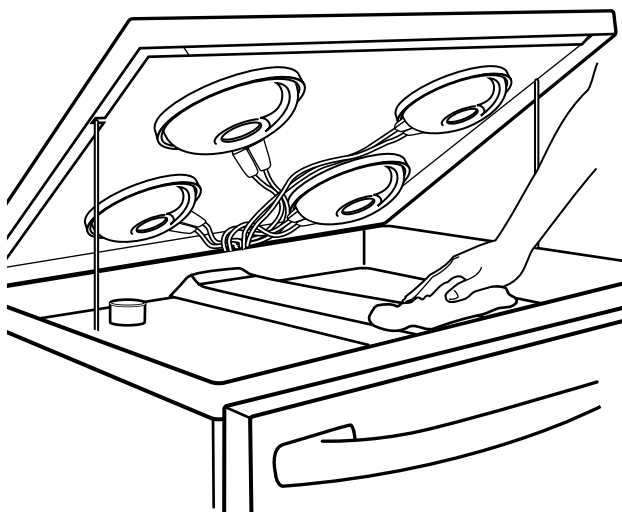

## REMOVING THE OVEN DOOR

For normal use of your range, you do not need to remove the door. However, if you have to remove the door follow the instructions in this section.

**NOTE:** If the door removal pins included in the Anti-Tip Bracket Package are not available, nails or screws may be used. Be careful that the length of the nail or screw does not damage the oven by chipping or scratching the porcelain surface.

### To remove:

1. Open the door about halfway. Insert door removal pins into both hinge hangers. **Do not remove them while the door is removed from the range.**
2. Close the door as far as the door removal pins will let you.

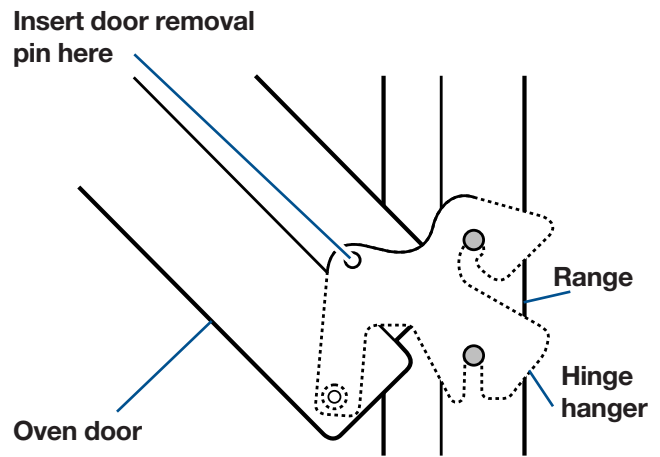

3. Rotate the door toward the range. Lift up the door until it stops. Do not use the door handle to lift the door. Rotate the door toward the floor and pull it toward you.

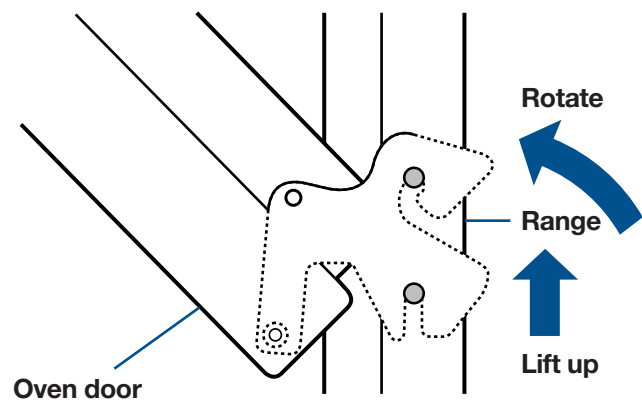
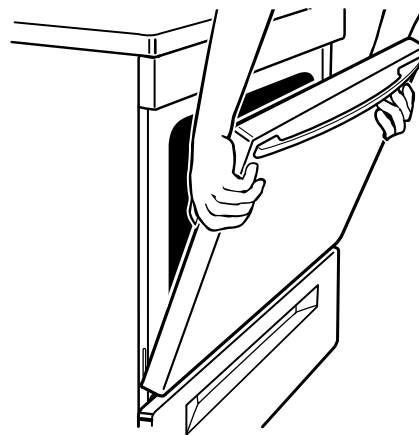

## REMOVING THE OVEN DOOR (CONT.)

### To replace:

**NOTE:** The door removal pins you inserted must still be in both sides of the door.

1. Grasp the door on the sides with your fingers on the front of the door and your thumbs on the inside surface.

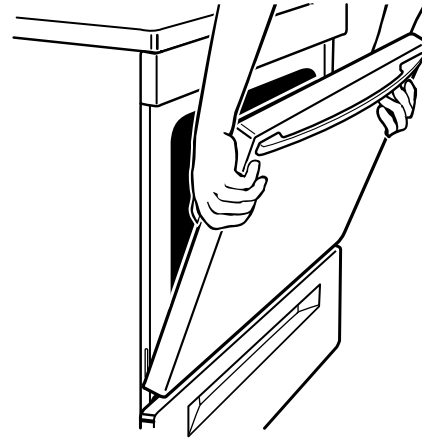

2. Rest the hinge hanger so that it is flat (at the bottom of the hinge hanger on the bottom of the front frame slot).
3. Position the door with the hinge hanger slots almost parallel to the front frame.
4. Push up and in until the hinge hanger slots become fastened to the range. Lower the door and rotate it slightly from the front to the back until the slots are fully fastened. The hinge hanger will be close to the bottom of the front frame slot.
5. Pull door open about halfway and remove the door removal pins. Save door removal pins for future use.
6. Close the door.

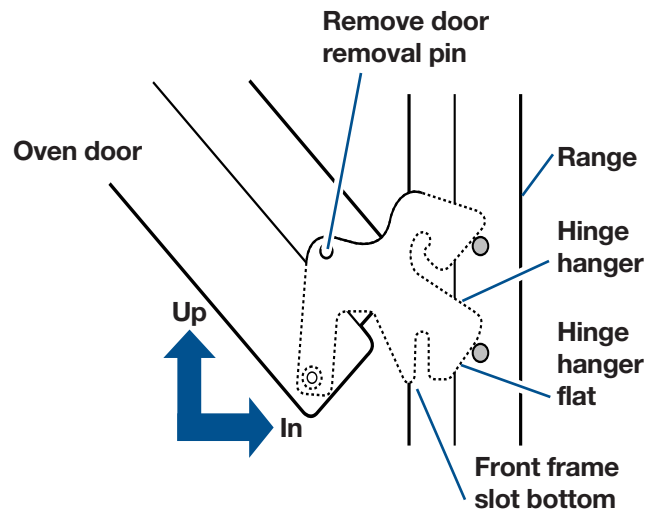

## THE OVEN LIGHT

The oven light will come on when you open the oven door.

### To turn the light on or off when the oven door is closed:

- Push the oven light switch on the backguard.

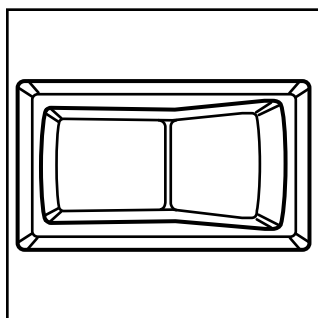

### To replace the oven light:

1. Unplug range or disconnect power.
2. Remove the glass bulb cover in the back of the oven by turning it counterclockwise.

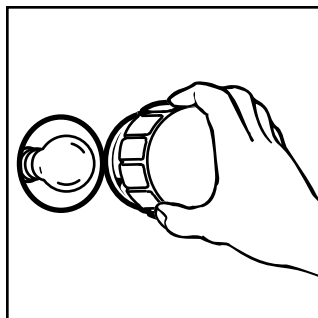

3. Remove the light bulb from its socket. Replace the bulb with a 40-watt appliance bulb.

4. Replace the light bulb cover by turning it clockwise.

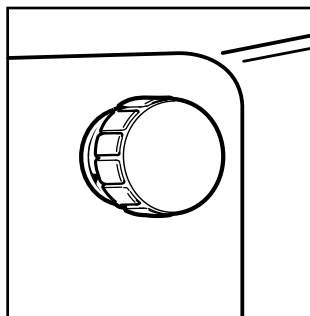

5. Plug in range or reconnect power.

# TROUBLESHOOTING

Most cooking problems often are caused by little things you can find and fix without tools of any kind. Check the lists below and on the next page before calling for assistance or service. If you still need help, see “Requesting Assistance or Service” on page 34.

## RANGE DOES NOT WORK

PROBLEM	CAUSE
Nothing works	<ul style="list-style-type: none"><li>• The range is not plugged into a live outlet with the proper voltage. (See Installation Instructions.)</li><li>• You have blown a household fuse or tripped a circuit breaker.</li><li>• The control knob is not set correctly. Push in the control knobs before turning them.</li></ul>
The oven does not work	<ul style="list-style-type: none"><li>• You have not set the electronic control correctly. Refer to the proper instructions.</li></ul>
The coil elements will not work	<ul style="list-style-type: none"><li>• You have blown a household fuse or tripped a circuit breaker.</li><li>• The coil elements are not plugged in all the way. (See “Replacing” on page 27.)</li><li>• You have not set the control knobs correctly. Push the control knobs in before turning them to a setting.</li></ul>

## COOKING RESULTS

PROBLEM	CAUSE
Cooking results are not what you expected	<ul style="list-style-type: none"><li>• The oven temperature seems too low or too high. See “Adjusting the oven temperature control” on page 17 to adjust the oven temperature.</li><li>• You did not preheat the oven before baking (if called for in the recipe).</li><li>• You are using a pan that is not the correct type or size. Refer to a reliable cookbook or recipe for the recommended pan type and size.</li><li>• There is not enough air space around the pan when baking. Allow 1½ to 2 inches of air space on all sides of the pan.</li><li>• The cookware is too large or too small for the coil element being used. The pan should be the same size or slightly larger than the coil element being used.</li><li>• The range is not level. (See the Installation Instructions.)</li></ul>



## DISPLAY MESSAGES

PROBLEM	CAUSE
The display is showing "PF"	● There has been a power failure. Press the off/cancel pad to clear the display.
"F" followed by a number shows on the display	● Press the off/cancel pad to clear the display. If an "F" code appears again, call for service. (See "If You Need Assistance or Service" on page 34.)
The indicator light(s) is flashing	● The function(s) indicated may not be working. Refer to the section in this Use and Care Guide discussing the function. If the indicator light(s) keeps flashing, call for service. (See "If You Need Assistance or Service" on page 34.)

If none of these items are causing your problem, see "Requesting Assistance or Service" on page 34.

# REQUESTING ASSISTANCE OR SERVICE

To avoid unnecessary service calls, please check the “Troubleshooting” section. It may save you the cost of a service call. If you still need help, follow the instructions below.

## IF YOU NEED ASSISTANCE OR SERVICE

**Call the Whirlpool Consumer Assistance Center toll free at 1-800-253-1301. Our consultants are available to assist you.**



When calling:

Please know the purchase date, and the complete model and serial number of your appliance (see the “A Note to You” section). This information will help us better respond to your request.

**Our consultants provide assistance with:**

- Features and specifications on our full line of appliances
- Installation information
- Use and maintenance procedures

- Accessory and repair parts sales
- Do-it-yourself repair help
- Specialized customer assistance (Spanish speaking, hearing impaired, limited vision, etc.)
- Referrals to local dealers, service companies, and repair parts distributors

**Whirlpool service technicians** are trained to fulfill the product warranty and provide after-warranty service, anywhere in the United States.

To locate the authorized Whirlpool service company in your area, you can also look in your telephone directory Yellow Pages.

## IF YOU NEED REPLACEMENT PARTS

If you need to order replacement parts, we recommend that you only use FSP® factory authorized parts. FSP replacement parts will fit right and work right, because they are made to the same exacting specifications used to build every new WHIRLPOOL® appliance.

To locate FSP replacement parts in your area, call our Consumer Assistance Center telephone number or your nearest authorized service center.

## FOR FURTHER ASSISTANCE

If you need further assistance, you can write to Whirlpool with any questions or concerns at:

Whirlpool Brand Home Appliances  
Consumer Assistance Center  
c/o Correspondence Dept.  
2000 North M-63  
Benton Harbor, MI 49022-2692

Please include a daytime phone number in your correspondence.

# INDEX

This index is alphabetical. It contains all the topics included in this manual, along with the page(s) on which you can find each topic.

<b>TOPIC</b>	<b>PAGE</b>	<b>TOPIC</b>	<b>PAGE</b>
AIR CIRCULATION .....	10	FEATURES .....	6
ANTI-TIP BRACKET .....	22	LIFT-UP COOKTOP .....	28
ASSISTANCE .....	34	MODEL AND SERIAL NUMBER .....	2
BAKING		OVEN DOOR .....	29
Aluminum foil .....	10	OVEN LIGHT .....	31
Pans .....	9, 10	OVEN TEMPERATURE	
Racks .....	9	Adjusting .....	17
Setting cycle .....	14, 15	Setting .....	14, 19
Tips .....	16	OVEN VENT .....	22
BROILING		PANS .....	9, 10
Grid .....	20	PARTS .....	6
Pan .....	18, 20	RACKS .....	9
Rack positions .....	20	ROASTING	
Setting cycle .....	19	Pans .....	9, 10
Tips .....	20	Racks .....	9
CLEANING		Setting cycle .....	14, 15
Broiler pan and grid .....	25	Tips .....	14
Coil elements .....	24, 26	SAFETY .....	3-5
Control knobs .....	24	SERVICE .....	34
Control panel .....	24	STORAGE DRAWER .....	23
Exterior surfaces .....	24	TIPS	
Oven cavity .....	25	Bakeware .....	9
Oven door glass .....	25	Broiling .....	20, 21
Oven racks .....	25	Cookware .....	8
Reflector bowls .....	24, 26	Roasting .....	14
COIL ELEMENTS		Saving energy .....	7, 16
Coil elements markers .....	6	TROUBLESHOOTING .....	32-33
Control knobs .....	7, 24	WARRANTY .....	36
Control setting guide .....	7		
Surface heating indicator light .....	6		
Tips .....	7		
CONTROL PANEL			
Coil element markers .....	6		
Control knobs .....	7		
Surface heating indicator light .....	6		
COOKWARE			
Canning .....	8		
Tips .....	8		
ELECTRONIC OVEN CONTROL			
Canceling .....	13		
Clock .....	12		
Control lock .....	11		
Display .....	11		
Indicator lights .....	11		
Minute timer .....	12		
Starting .....	13		

# WARRANTY

## WHIRLPOOL® ELECTRIC RANGE

LENGTH OF WARRANTY	WHIRLPOOL WILL PAY FOR
<b>FULL ONE-YEAR WARRANTY</b> FROM DATE OF PURCHASE	FSP® replacement parts and repair labor to correct defects in materials or workmanship. Service must be provided by an authorized Whirlpool service company.
WHIRLPOOL WILL NOT PAY FOR	
<p><b>A.</b> Service calls to:</p> <ol style="list-style-type: none"> <li>1. Correct the installation of your range.</li> <li>2. Instruct you how to use your range.</li> <li>3. Replace house fuses or correct house wiring.</li> <li>4. Replace owner-accessible light bulbs.</li> </ol> <p><b>B.</b> Repairs when your range is used in other than normal, single-family household use.</p> <p><b>C.</b> Pickup and delivery. Your range is designed to be repaired in the home.</p> <p><b>D.</b> Damage to your range caused by accident, misuse, fire, flood, acts of God, or use of products not approved by Whirlpool.</p> <p><b>E.</b> Repairs to parts or systems caused by unauthorized modifications made to the appliance.</p>	

3/96

**WHIRLPOOL CORPORATION SHALL NOT BE LIABLE FOR INCIDENTAL OR CONSEQUENTIAL DAMAGES.** Some states do not allow the exclusion or limitation of incidental or consequential damages, so this exclusion or limitation may not apply to you. This warranty gives you specific legal rights, and you may also have other rights which vary from state to state.

**Outside the United States, a different warranty may apply. For details, please contact your authorized Whirlpool dealer.**

If you need service, first see the “Troubleshooting” section of this book. After checking “Troubleshooting,” additional help can be found by checking the “Requesting Assistance or Service” section, or by calling the Whirlpool Consumer Assistance Center telephone number, **1-800-253-1301**, from anywhere in the U.S.A.